



South Sea Semiconductor

# SSM8405

## Dual Enhancement Mode MOSFET

Product Summary (N-Channel)		
V <sub>DS</sub> (V)	I <sub>D</sub> (A)	R <sub>DS(ON)</sub> (mΩ) Max
30V	7A	25 @V <sub>GS</sub> = 10V
		35 @V <sub>GS</sub> = 5V
		40 @V <sub>GS</sub> = 4.5V

Product Summary (P-Channel)		
V <sub>DS</sub> (V)	I <sub>D</sub> (A)	R <sub>DS(ON)</sub> (mΩ) Max
- 30V	- 5A	45 @V <sub>GS</sub> = - 10V
		75 @V <sub>GS</sub> = - 5V
		90 @V <sub>GS</sub> = - 4.5V

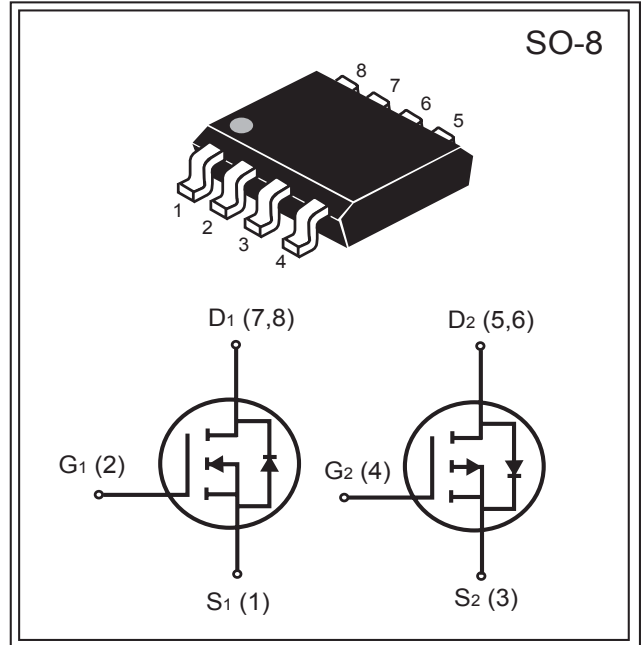

ABSOLUTE MAXIMUM RATINGS (T <sub>A</sub> = 25 °C unless otherwise noted)					
Parameter	Symbol	N-Channel Limited	P-Channel Limited	Unit	
Drain-Source Voltage	V <sub>DS</sub>	30	-30	V	
Gate-Source Voltage	V <sub>GS</sub>	±25	±25		
Drain Current-Continuous @ T <sub>a</sub>	I <sub>D</sub>	25 °C	7	-5	A
		70 °C	6	-4.5	
-Pulsed <sup>b</sup>	I <sub>DM</sub>	30	-20		
Drain-Source Diode Forward Current <sup>a</sup>	I <sub>S</sub>	1.6	-1.6		
Maximum Power Dissipation <sup>a</sup>	P <sub>D</sub>	T <sub>a</sub> =25 °C	2.0		W
		T <sub>a</sub> =70 °C	1.44		
Operating Junction and Storage Temperature Range	T <sub>J</sub> , T <sub>STG</sub>	-55 to 150		°C	
THERMAL CHARACTERISTICS					
Thermal Resistance, Junction-to-Ambient <sup>a</sup>	R <sub>θJA</sub>	62.5		°C/W	

South Sea Semiconductor reserves the right to make changes to improve reliability or manufacturability without advance notice.

South Sea Semiconductor, October 2007 (Rev 3.0)



N-Channel Electrical Characteristics (T <sub>A</sub> = 25°C unless otherwise noted)						
Parameter	Symbol	Condition	Min	Typ <sup>c</sup>	Max	Unit
Drain-Source Breakdown Voltage	BV <sub>DSS</sub>	V <sub>GS</sub> =0V, I <sub>D</sub> =250 μA	30			V
Zero Gate Voltage Drain Current	I <sub>DSS</sub>	V <sub>DS</sub> =24V, V <sub>GS</sub> =0V			1	μA
Gate-Body Leakage	I <sub>GSS</sub>	V <sub>GS</sub> =±25V, V <sub>DS</sub> =0V			±100	nA
Gate Threshold Voltage	V <sub>GS(th)</sub>	V <sub>DS</sub> =V <sub>GS</sub> , I <sub>D</sub> =250 μA	1	1.6	2	V
Drain-Source On-State Resistance	R <sub>DS(ON)</sub>	V <sub>GS</sub> =10V, I <sub>D</sub> =6.6A		18	25	mΩ
		V <sub>GS</sub> =5V, I <sub>D</sub> =5A		28	35	
		V <sub>GS</sub> =4.5V, I <sub>D</sub> =5A		32	40	
On-State Drain Current	I <sub>D(ON)</sub>	V <sub>DS</sub> =5V, V <sub>GS</sub> =4.5V	20			A
Forward Transconductance	g <sub>FS</sub>	V <sub>DS</sub> =5V, I <sub>D</sub> =6.6A		10		S
Input Capacitance	C <sub>ISS</sub>	V <sub>DS</sub> =15V		766	853	pF
Output Capacitance	C <sub>OSS</sub>	V <sub>GS</sub> =0V		142	166	
Reverse Transfer Capacitance	C <sub>RSS</sub>	f=1.0MHz		98	122	
Turn-On Delay Time	t <sub>D(ON)</sub>	V <sub>DD</sub> =15V,		7.5	10	ns
Rise Time	t <sub>r</sub>	I <sub>D</sub> =6.6A,		27.5	35	
Turn-Off Delay Time	t <sub>D(OFF)</sub>	V <sub>GS</sub> =10V,		12	22	
Fall Time	t <sub>f</sub>	R <sub>GEN</sub> =3Ω		7.5	12	
Total Gate Charge	Q <sub>g</sub>	V <sub>DS</sub> =10V, I <sub>D</sub> =6.6A, V <sub>GS</sub> =10V		14	18	nC
		V <sub>DS</sub> =10V, I <sub>D</sub> =6.6A, V <sub>GS</sub> =4.5V		6	10	
Gate-Source Charge	Q <sub>gs</sub>	V <sub>DS</sub> =15V I <sub>D</sub> =6.6A,		2.3	4	
Gate-Drain Charge	Q <sub>gd</sub>	V <sub>GS</sub> =10V		4	6	
Diode Forward Voltage	V <sub>SD</sub>	V <sub>GS</sub> =0V, I <sub>D</sub> =1.6A		0.8	1.2	

South Sea Semiconductor reserves the right to make changes to improve reliability or manufacturability without advance notice.



## P-Channel Electrical Characteristics (T<sub>A</sub> = 25°C unless otherwise noted)

Parameter	Symbol	Condition	Min	Typ <sup>c</sup>	Max	Unit
Drain-Source Breakdown Voltage	BV <sub>DSS</sub>	V <sub>GS</sub> =0V, I <sub>D</sub> = - 250μA	- 30			V
Zero Gate Voltage Drain Current	I <sub>DSS</sub>	V <sub>DS</sub> =-24V, V <sub>GS</sub> =0V			-1	μA
Gate-Body Leakage	I <sub>GSS</sub>	V <sub>GS</sub> = ±25V, V <sub>DS</sub> =0V			±100	nA
Gate Threshold Voltage	V <sub>GS(th)</sub>	V <sub>DS</sub> =V <sub>GS</sub> , I <sub>D</sub> = - 250μA	-1	-1.9	-2.5	V
Drain-Source On-State Resistance	R <sub>DS(ON)</sub>	V <sub>GS</sub> = - 10V, I <sub>D</sub> = - 5A		38	45	mΩ
		V <sub>GS</sub> = - 5V, I <sub>D</sub> = - 3.5A		65	75	
		V <sub>GS</sub> = - 4.5V, I <sub>D</sub> = - 3.0A		80	90	
On-State Drain Current	I <sub>D(ON)</sub>	V <sub>DS</sub> = - 5V, V <sub>GS</sub> = - 10V	20			A
Forward Transconductance	g <sub>FS</sub>	V <sub>DS</sub> = - 5V, I <sub>D</sub> = - 5A		10		S
Input Capacitance	C <sub>ISS</sub>	V <sub>DS</sub> =-15V V <sub>GS</sub> =0V f=1.0MHz		720	845	pF
Output Capacitance	C <sub>OSS</sub>			155	185	
Reverse Transfer Capacitance	C <sub>RSS</sub>			90	125	
Gate Resistance	R <sub>g</sub>	V <sub>GS</sub> =0V, V <sub>DS</sub> =0V, f=1.0MHz		3.5		
Turn-On Delay Time	t <sub>D(ON)</sub>	V <sub>DD</sub> = - 15V, V <sub>GS</sub> = - 10V, R <sub>GEN</sub> =3Ω, R <sub>L</sub> =2.7Ω		4.5	14	ns
Rise Time	t <sub>r</sub>			8	30	
Turn-Off Delay Time	t <sub>D(OFF)</sub>			47	75	
Fall Time	t <sub>f</sub>			22.5	35	
Total Gate Charge	Q <sub>g</sub>	V <sub>DS</sub> =-15V, I <sub>D</sub> =-5A, V <sub>GS</sub> =-10V		14	16	nC
		V <sub>DS</sub> =-15V, I <sub>D</sub> =-5A, V <sub>GS</sub> =-4.5V		7	10	
Gate-Source Charge	Q <sub>gs</sub>	V <sub>DS</sub> = - 15V, I <sub>D</sub> = - 5A, V <sub>GS</sub> = -10V		1.5	2.8	
Gate-Drain Charge	Q <sub>gd</sub>			4.2	6	
Diode Forward Voltage	V <sub>SD</sub>	V <sub>GS</sub> =0V, I <sub>D</sub> = -1.6A		-0.8	-1.2	V

Notes :

- a. Surface Mounted on FR4 Board, t ≤ 10 sec.
- b. Pulse Test : Pulse Width ≤ 300 μs, Duty Cycle ≤ 2%.
- c. Guaranteed by design, not subject to production testing.

South Sea Semiconductor reserves the right to make changes to improve reliability or manufacturability without advance notice.



## N-Channel

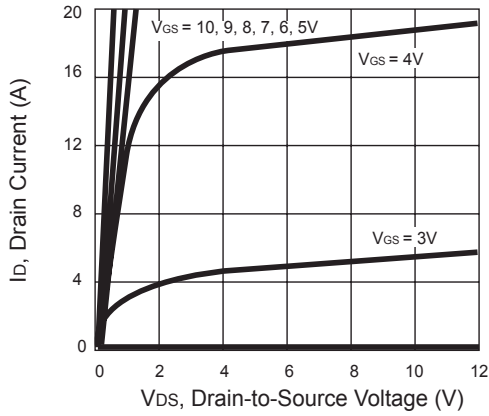

Figure 1. Output Characteristics

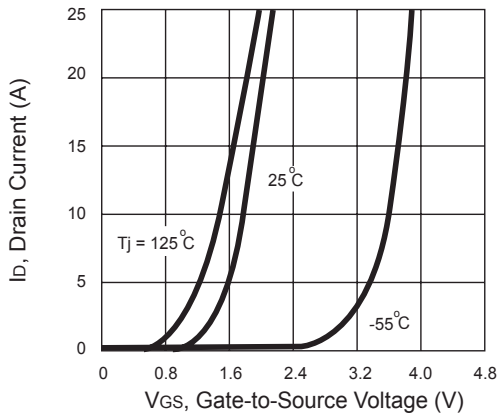

Figure 2. Transfer Characteristics

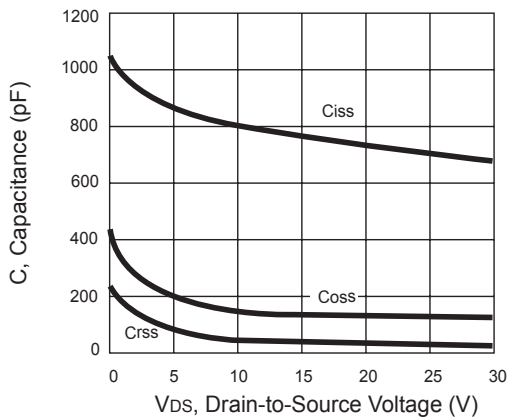

Figure 3. Capacitance

## P-Channel

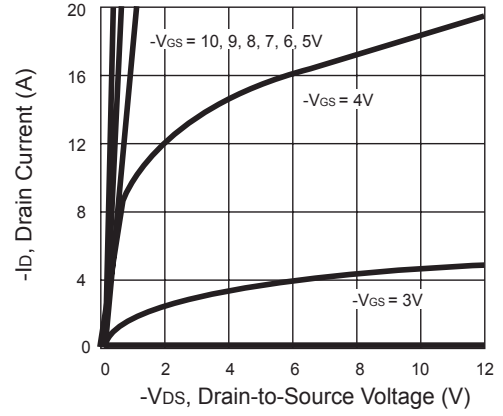

Figure 1. Output Characteristics

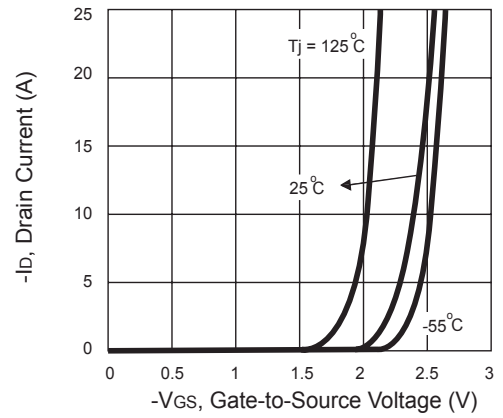

Figure 2. Transfer Characteristics

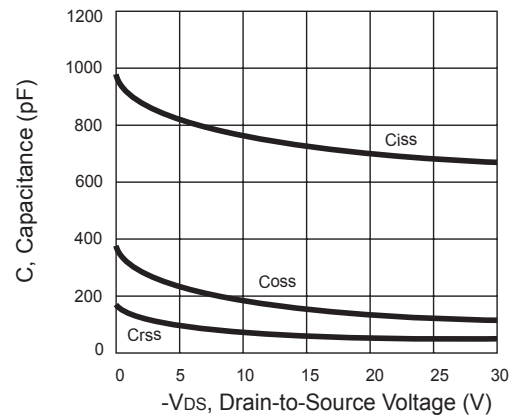

Figure 3. Capacitance



## N-Channel

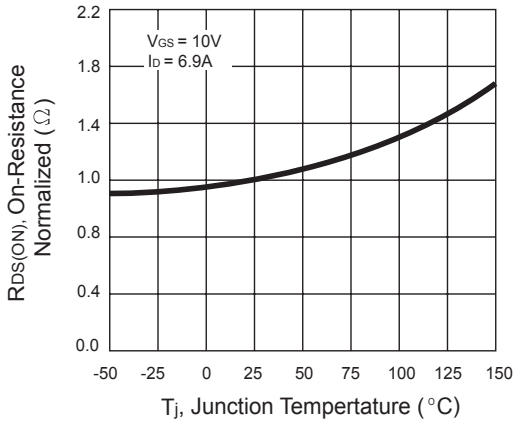

Figure 4. On-Resistance Variation with Temperature

## P-Channel

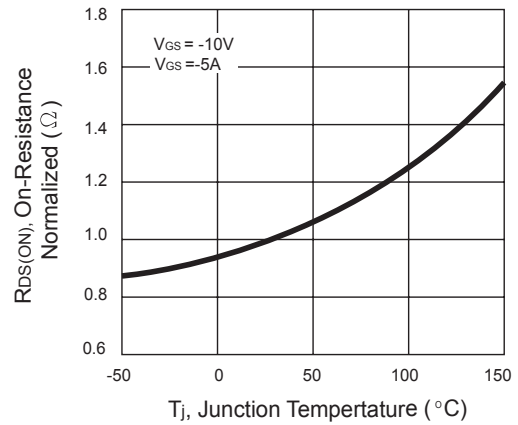

Figure 4. On-Resistance Variation with Temperature

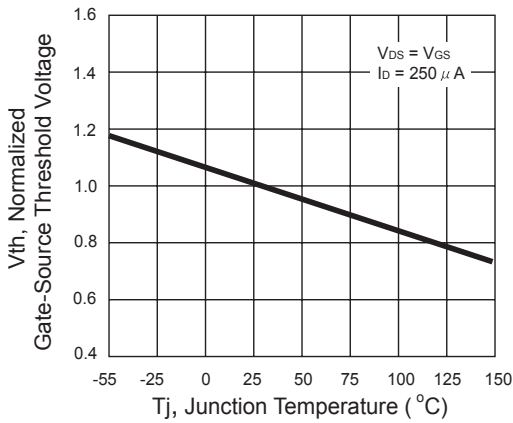

Figure 5. Gate Threshold Variation with Temperature

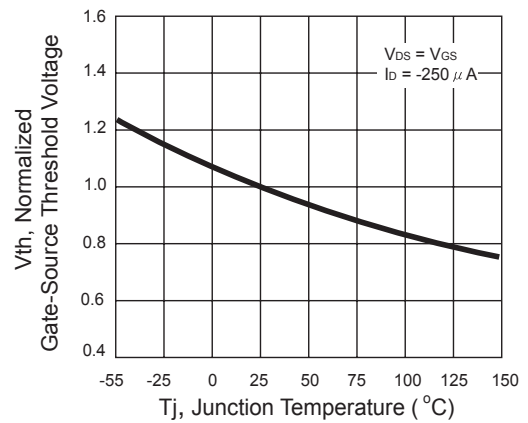

Figure 5. Gate Threshold Variation with Temperature

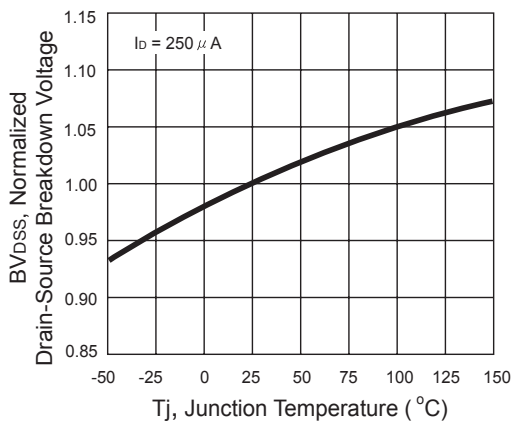

Figure 6. Breakdown Voltage Variation with Temperature

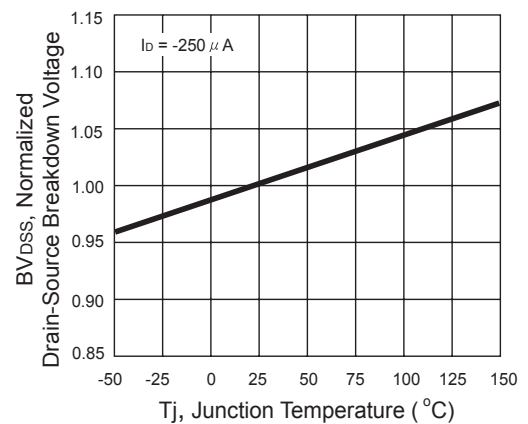

Figure 6. Breakdown Voltage Variation with Temperature



## N-Channel

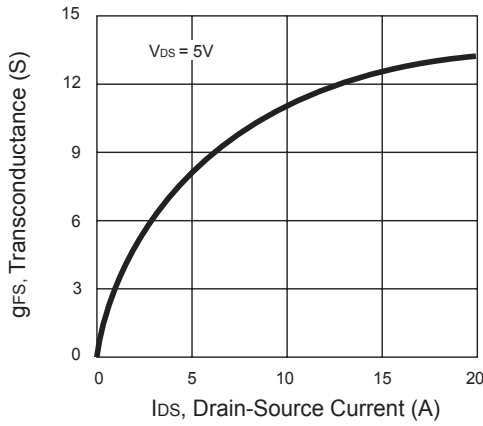

Figure 7. Transconductance Variation with Drain Current

## P-Channel

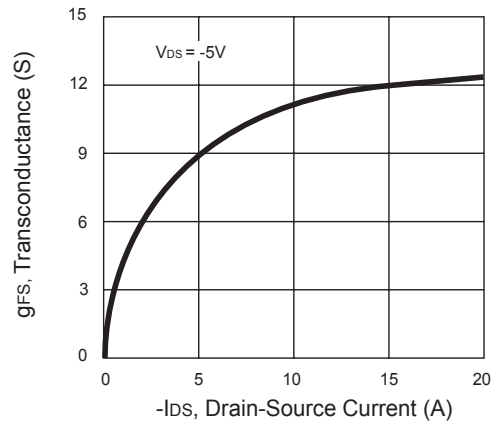

Figure 7. Transconductance Variation with Drain Current

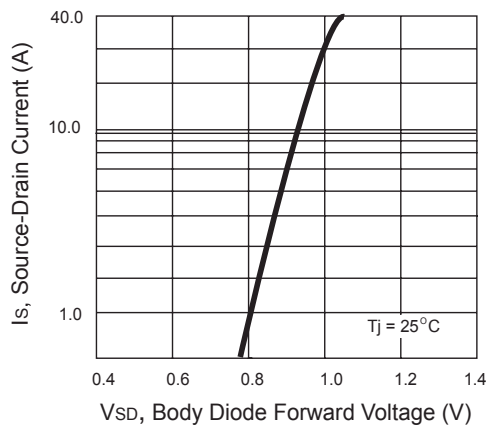

Figure 8. Body Diode Forward Voltage Variation with Source Current

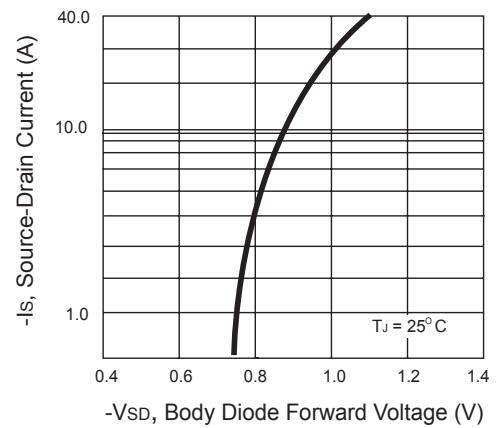

Figure 8. Body Diode Forward Voltage Variation with Source Current

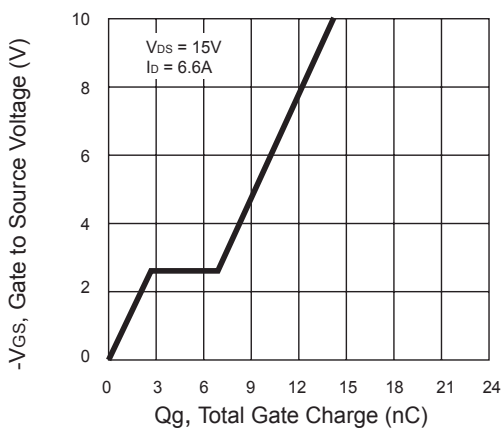

Figure 9. Gate Charge

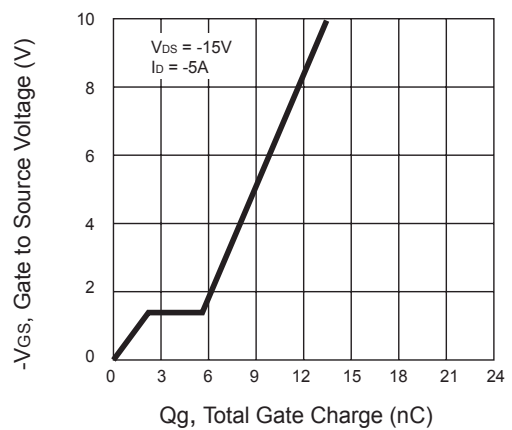

Figure 9. Gate Charge



## N-Channel

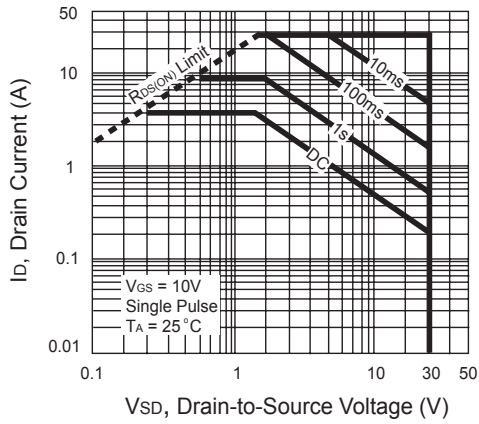

Figure 10. Maximum Safe Operating Area

## P-Channel

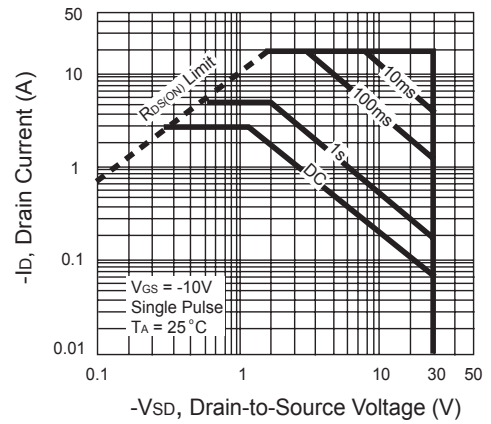

Figure 10. Maximum Safe Operating Area

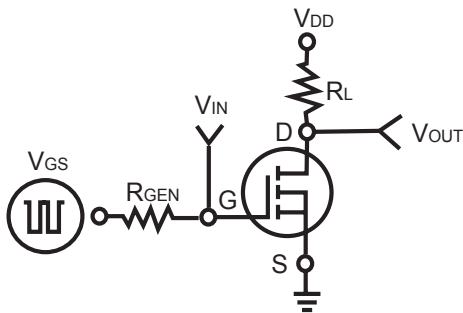

Figure 11. Switching Test Circuit

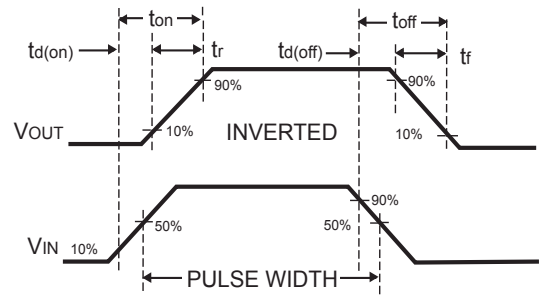

Figure 12. Switching Waveforms



## N-Channel

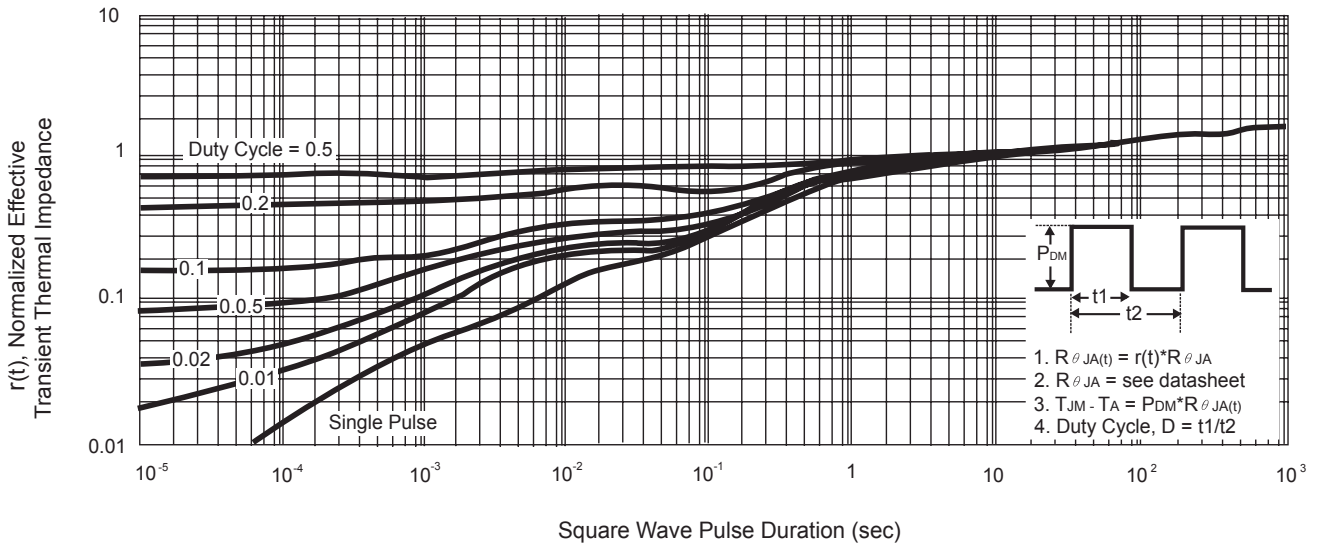

Figure 13. Normalized Thermal Transient Impedance Curve

## P-Channel

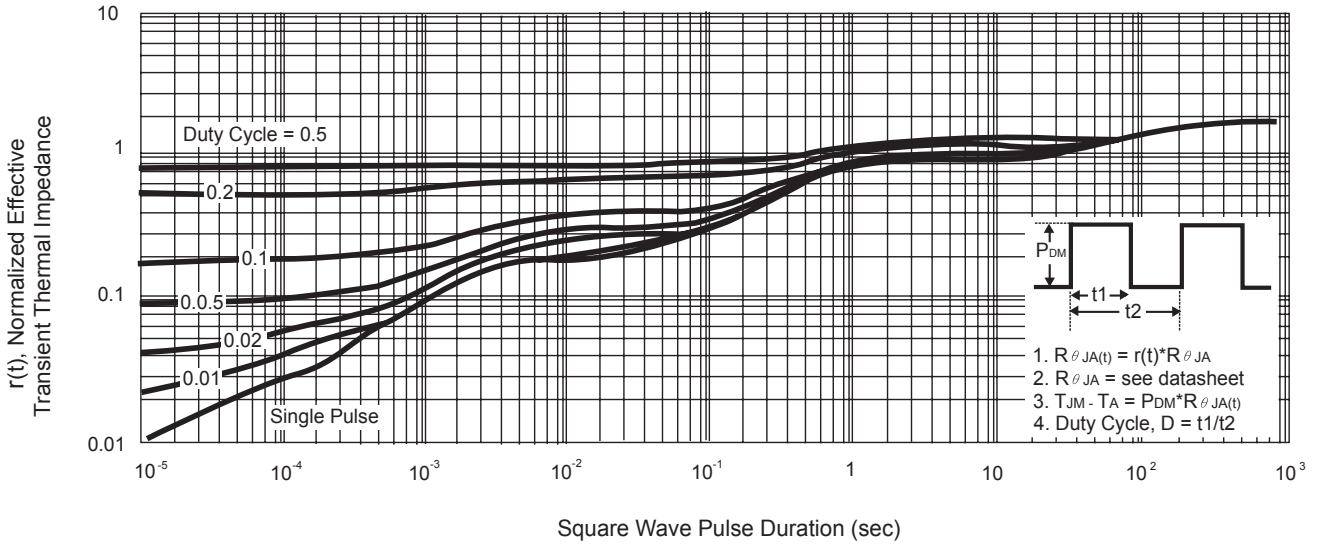

Figure 13. Normalized Thermal Transient Impedance Curve





## Package Outline Dimensions

SO-8

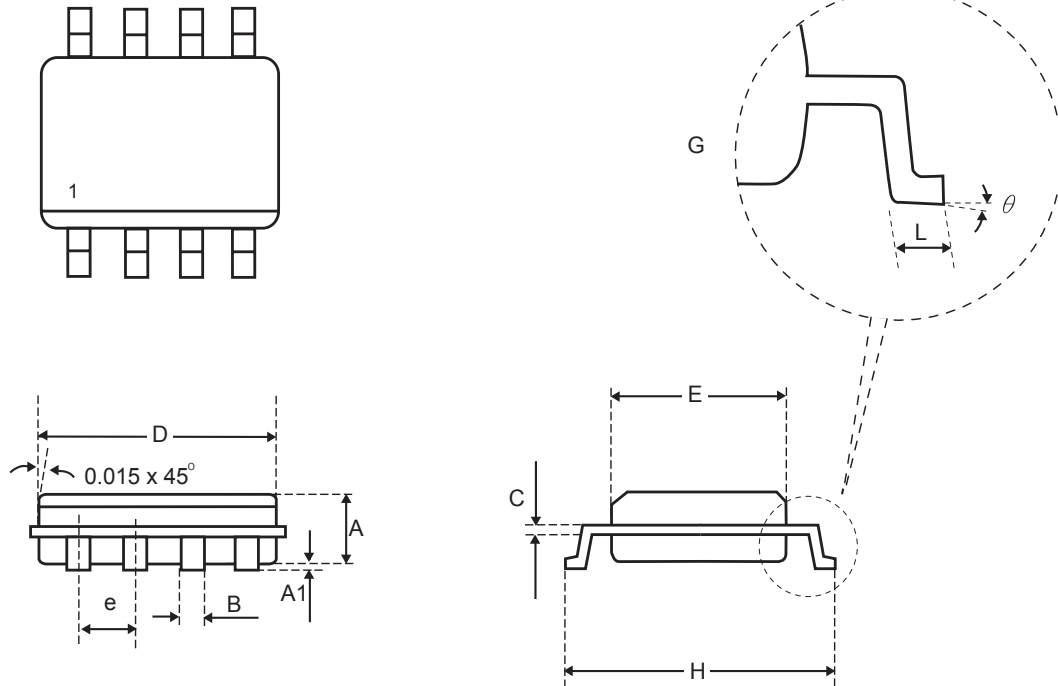

SYMBOLS	MILLIMETERS		INCHES	
	Min.	Max.	Min.	Max.
A	1.35	1.75	0.053	0.069
A1	0.10	0.25	0.004	0.010
B	0.41 Typ.		0.016 Typ.	
C	0.20 Typ.		0.008 Typ.	
D	4.80	4.98	0.189	0.196
E	3.81	3.99	0.150	0.157
e	1.25 Typ.		0.05 Typ.	
H	5.79	6.20	0.228	0.244
L	0.41	1.27	0.016	0.050
$\theta$	0°	8°	0°	8°

South Sea Semiconductor reserves the right to make changes to improve reliability or manufacturability without advance notice.

South Sea Semiconductor, October 2007 (Rev 3.0)



## Carrier Tape & Reel Dimensions

SO-8

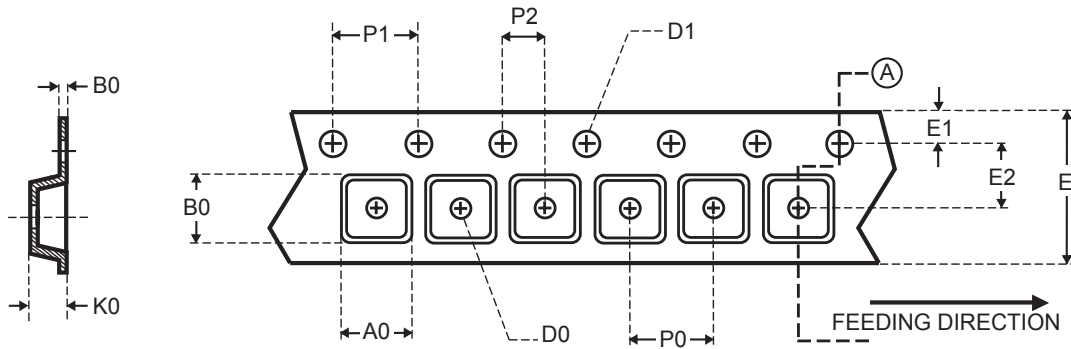

Package	A0	B0	K0	D0	D1	E	E1	E2	P0	P1	P2	T
SOP 8N 150 mil	6.40	5.20	2.10	$\phi 1.50$ (Min.)	$\phi 1.50$ +0.10 -0.10	12.00 $\pm 0.30$	1.75	5.50 $\pm 0.05$	8.00	4.00	2.00 $\pm 0.05$	0.30 $\pm 0.05$

UNIT : mm

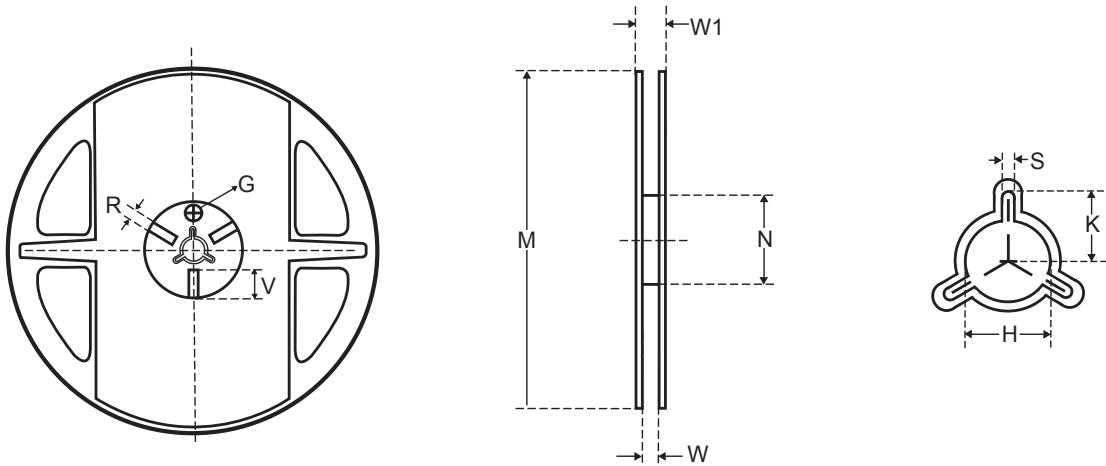

Tape size	Reel Size	M	N	W	W1	H	K	S	G	R	V
12mm	$\phi 330$	330 $\pm 1$	62 $\pm 1.5$	12.4 $\pm 0.2$	16.8 -0.4	$\phi 12.75$ $\pm 0.15$	-	2.0 $\pm 0.15$	-	-	-

UNIT : mm